



QuietRF Application Notes

Installation instructions for QuietRock RF, QuietWood RF and QuietSeam RF in construction of high security environments such as Sensitive Compartmented Information Facilities (SCIF) and government offices for both radio frequency (RF) and acoustic frequency (AF) transmission mitigation.

Preparation

- Frame out the enclosure using metal stud walls and metal joists/hat channels for the ceiling. Optionally, for best acoustical performance run two 3/8" beads of QuietSeal between:
 - Base plate and the floor
 - Top plate and the ceiling
 - Any studs that touch an existing wall
- Electrically connect all wall studs, joists, and hat channels to a common ground.

Application

Stage 1: Floor Installation

1. Install QuietFoam on the existing concrete slab:
 - Roll the QuietFoam across the slab and three inches (3") up the stud walls.
 - The foam may be secured with single-sided tape or double stick carpet tape with a rubber or acrylic-based adhesive.

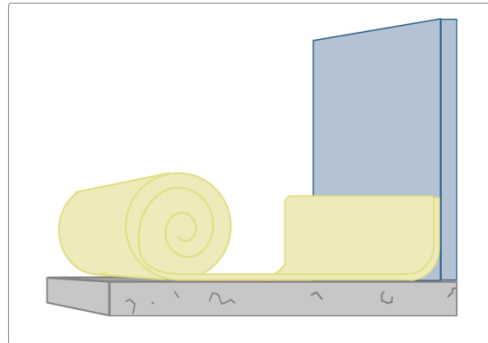

2. Install plywood:
 - Use the plywood to push the QuietFoam into the corner.
 - The wood may be secured to the foam with construction adhesive or double stick carpet tape with a rubber or acrylic-based adhesive.

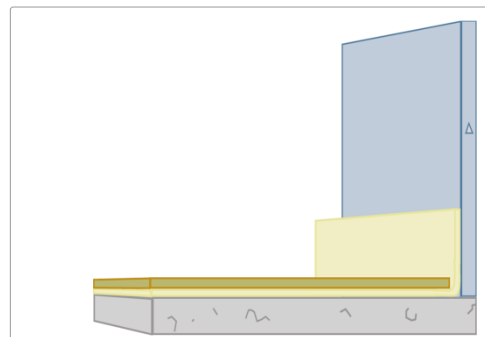

3. Install QuietWood RF:

- Stagger the joints between the QuietWood RF and the plywood.
- The QuietWood RF must be installed with the conductive metal trim face up.
- The edges of the QW-630 RF panel at the perimeter of the floor must also have the conductive metal trim exposed.
- If the panels need to be trimmed follow the panel trimming directions below.
- The panels may be secured to the plywood with construction adhesive or double stick carpet tape.

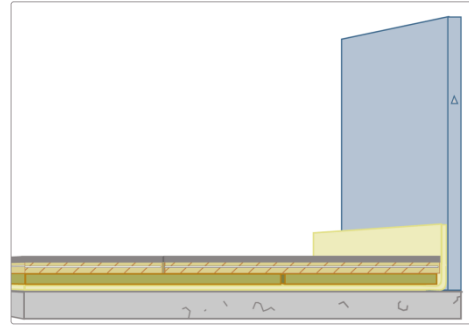

4. Trim the QuietFoam:

- Trim back the QuietFoam at the edges of the room so that it is even with the QuietWood RF.

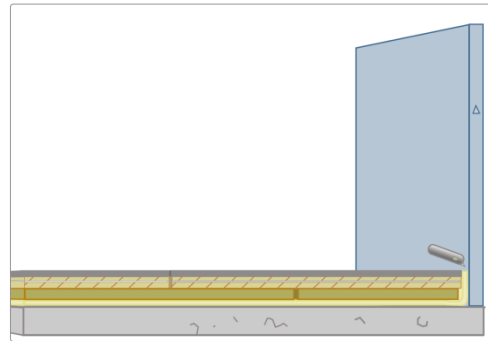

5. Tape the QW-630 RF seams:

- Apply an approved 3/4" wide electrically conductive tape between adjacent QuietWood RF panels. (See tape note below)
- Make sure that the newly applied tape overlaps the conductive metal trim on both the adjacent panels.
- Before beginning other construction tasks, cover the floor panels with a protective layer to avoid damage to the conductive panel edges.

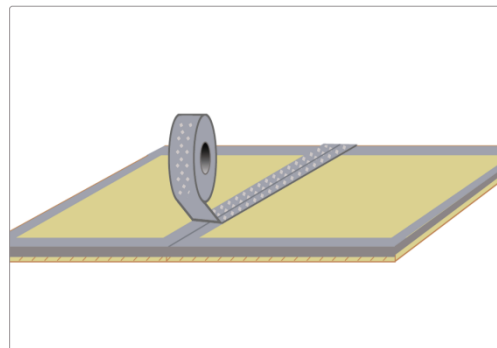

Stage 2: Ceiling Installation

6. Install QuietRock QR-530RF:

- The QuietRock QR-530RF must be installed with the conductive metal trim exposed to the room interior.
- The edges of the panels at the perimeter of the ceiling must also have conductive metal trim exposed to the room interior.
- If the panels need to be trimmed follow the trimming directions below.

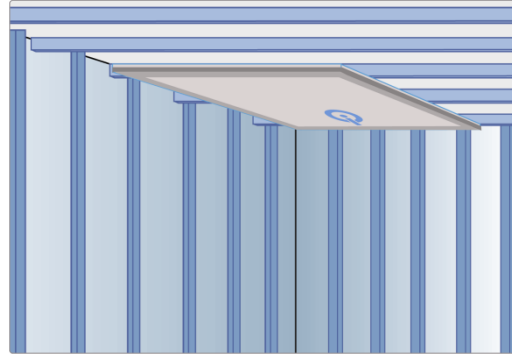

7. Attach panels:

- For best results, the ceiling panels should be screwed into the metal joists or hat channels.
- Use black phosphate fine thread drywall screws such as those available from Grip Rite Fas'ners.

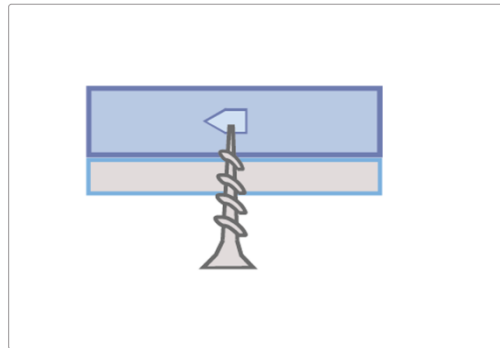

8. Screw Pattern:

- Install screws every 8 inches at the edge of the panel along the studs and every 12 inches in the field (center of the panel) along the studs.

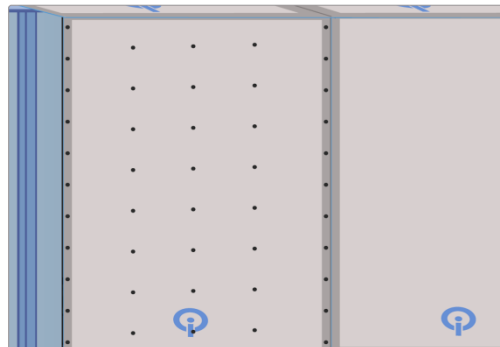

Stage 3: Walls and Joints

Proper Installation at Corners

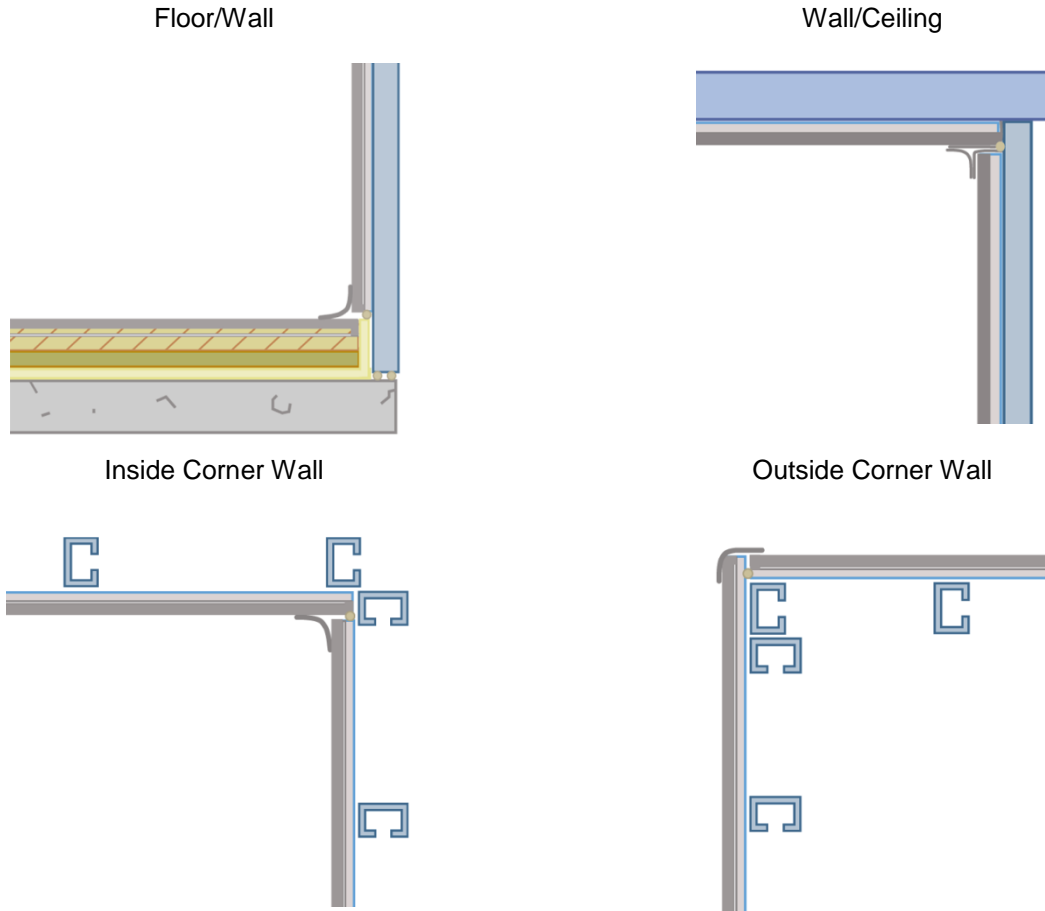

9. Apply Acoustical QuietSeal:

- Run a bead of standard QuietSeal along the perimeter of the floor and ceiling.
- Angle the tube toward you and move the tube away from you. This will push the QuietSeal into the edge.
- Note: Use standard QuietSeal and not QuietSeam RF

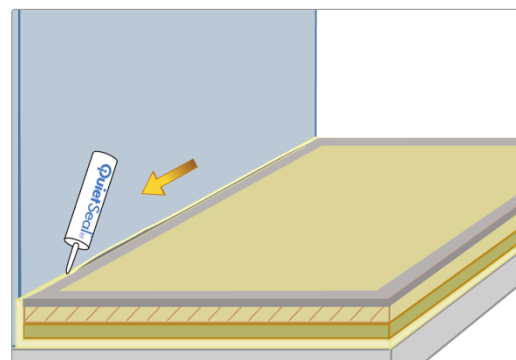

10. Install QuietRock RF:

- Orient the panels so that the conductive metal trim is installed facing the interior of the room.
- The edges of the panel at the perimeter must have conductive metal trim exposed.
- If the panels need to be trimmed follow the trimming directions below.
- See the details above for proper installation at the corners.

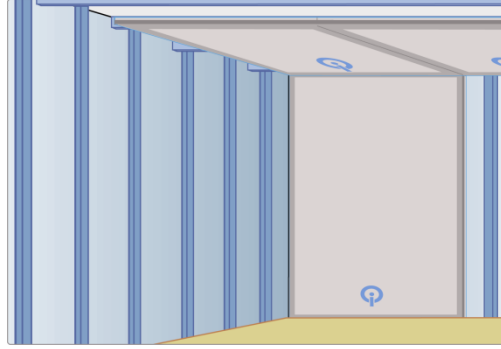

11. Attach panels:

- The panels must be screwed into the metal studs.
- Install screws every 8 inches at the edge of the panel along the studs and every 12 inches in the field (center of the panel) along the studs.
- Use black phosphate fine thread drywall screws such as those available from Grip Rite Fas'ners.

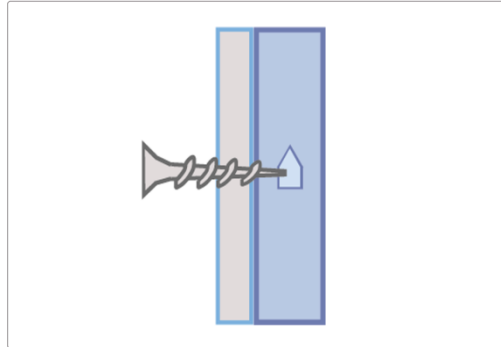

12. Tape the seams:

- Apply an approved 3/4" wide electrically conductive tape between adjacent QuietRock QR-530RF panels. (See tape note below)
- Make sure that the newly applied tape overlaps the conductive metal trim on both the adjacent panels.

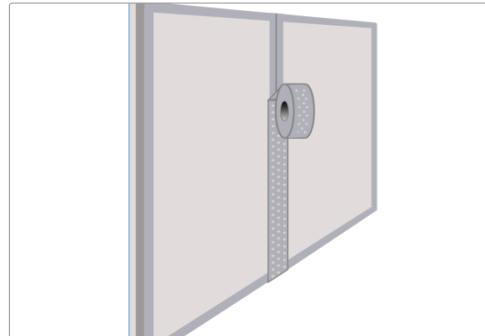

13. Tape the edges:

- Apply an approved 3/4" wide electrically conductive tape along the edge of each wall and the adjacent wall/floor/ceiling. (See tape note below)
- Make sure that the newly applied tape overlaps the conductive metal trim on both the wall and floor panels.

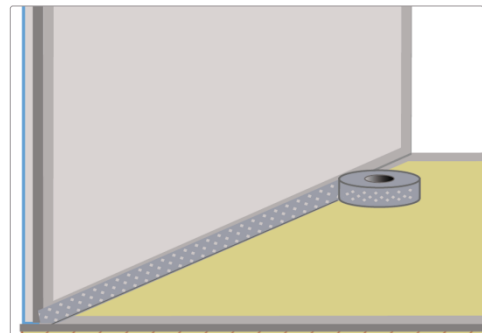

Finish as Usual

- Apply an approved 3/4" wide electrically conductive tape along the edge of each wall and the adjacent wall/floor/ceiling. (See tape note below)
- After the QuietRock and RF tape are in place, apply drywall tape along the joints between the two pieces of drywall. The tape helps hold drywall compound in the gap.
- Use a wide drywall knife to spread joint compound over the tape. Don't try to fill the entire gap all at once; apply a little at a time, and allow it to dry before applying a second coat.
- Cover the screw heads with drywall compound.
- Allow the joint compound to dry then sand it smooth. Wear breathing protection during this step because the process generates a lot of dust.
- Apply a second coat of drywall compound, allow it to dry, and sand it smooth. Repeat the process as necessary until the wall is perfectly smooth then finish the wall as desired. **BE SURE TO FOLLOW THE COMPOUND MANUFACTURERS INSTRUCTIONS.**

Trimming

Trimming installation procedure must be followed when installing less than a full panel. The procedure is the same for QuietRock RF and QuietWood RF.

1. Trim the panel to size:

- Use a saw to trim the panel to the proper size.
- See note below for saw and blade selection.

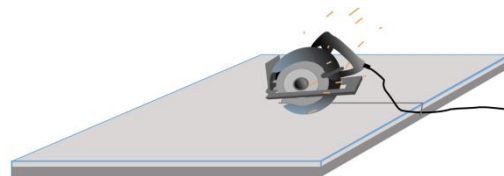

2. Orient the panel:

- Place panel down with conductive metal trim on the exposed face.



3. Apply tape to cut edge

- Apply an approved two-inch (2") wide electrically conductive tape (See note below) to the panel face with 1/2" to 3/4" inch of tape applied to the panel face, leaving the extra tape overhanging.

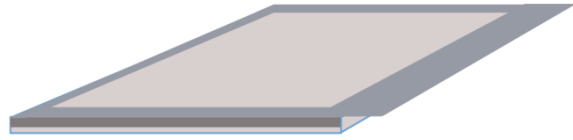

4. Turn panel over:

- Flip panel so that the metal tape is now sticky side up.

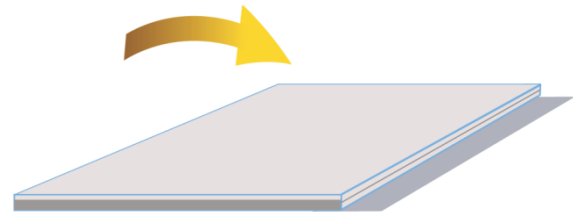

5. Apply QuietSeam RF:

- Spread QuietSeam RF on the cut edge with a putty knife or run a 3/8" bead of QuietSeam RF on the metal tape along the edge of the panel. Make sure to coat the exposed metal edge in the panel's core.

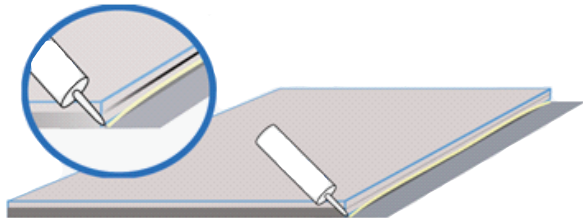

Note: The top of the QuietSeam RF may dry out over time in storage. Remove and dispose of any hardened material. Mix the remaining material thoroughly before use.

6. Fold the tape:

- Fold the metal tape over the QuietSeam RF as to ensure the QuietSeam RF touches the exposed metal sheet in the panel.

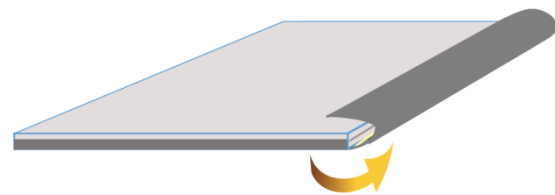

7. Final Product:

- The final trimmed panel should have QuietSeam RF held in place with the metal tape.

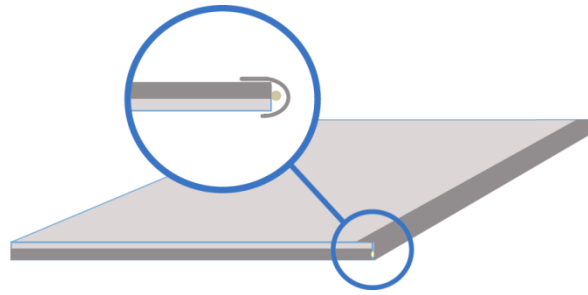

Recommended Saws, Blades and Vacuum System

Circular Saw

Makita 5057KB 7¼" Circular Saw w/ Dust Box
TENRYU steel pro PRF-18548BW (or equal)

Jig Saw

Makita 4334DWD 18v Variable Speed Jigsaw
Makita 7230123 10 Pack 24 tpi Blades 3-1/8" (or equal)
Makita 7230084 10 Pack 24 tpi Blades 2-3/8"

Cutout Tool

Makita 3706 Drywall Router
Makita 733341A ¼" Solid Carbide Bit (3706)

Vacuum System

Makita XSV10 10 Gal. Wet/Dry Vacuum
Makita 1934577 Vacuum Attachment (3706) (for drywall router)
Makita 1922023 Rubber Sleeve ¾" I.D x 7/8" O.D. (for jig saw)
Makita 1924180 Vacuum Attachment (4334DWD) (for jig saw)
Makita 1922798 10 Ft. Hose (3706,4334DWD)*
Makita 410871A Hose Adapter (3706,4334DWD)*
Makita 110001A Cartridge Filter (XSV10)

Tips

- The connection will take 1 to 3 days to fully cure / connect.
- When using the 3M 1345 EMI Embossed Tin-Plated Copper Foil Shielding Tape, make sure that it is firmly adhered to the surface to ensure an adequate electrical connection.

Electrically Conductive Metal Tape

Use electrically conductive tape such as QuietRF Shielding Tape, available through Serious Materials. The tape must be conductive through the adhesive. Two inch (2") wide tape is required for cut edges of panels. ¾" wide tape should be used at panel seams.

Doors, Windows and Outlets

Use RF shielded doors, windows and outlets. Follow manufactures directions to maintain RF shielding.

Notes

Use normal care and precaution when working with Quiet Solution products:

- *Cleanup with soap and water.*
- *Follow all OSHA guidelines when completing any construction project.*
- *QuietRock RF, QuietWood RF, QuietSeal and QuietSeam RF contain no hazardous materials.*
- *Dispose of excess Quiet Solution products in the same responsible manner as you would any building material.*

Warning - Avoid Breathing Silica Dust

Quiet Solution products, like most gypsum wallboard products, contain silica. Inhalation of respirable silica can cause silicosis which is a potentially disabling lung disease, and which is known to the State of California to cause lung cancer. When drilling, cutting, or abrading products during installation or handling: (1) Work outdoors where feasible, otherwise use mechanical ventilation, (2) Wear a dust mask, or if dust may exceed PEL, use NIOSH/MSHA approved respirator (recommended), (3) Warn others in area. According to medical experts, and the Surgeon General for the United States, cigarette smoking can significantly increase your likelihood for contracting lung-related diseases, including silica-related lung diseases. For further information, refer to our installation instructions and Material Safety Data Sheet available at www.QuietSolution.com or by calling 1-800-797-8159. FAILURE TO ADHERE TO WARNINGS, MSDS, AND INSTALLATION INSTRUCTIONS MAY LEAD TO SERIOUS PERSONAL INJURY.

For further information see the Material Safety Data Sheets (MSDS) on line at www.QuietSolution.com.

Serious Materials, Inc.
1250 Elko Drive
Sunnyvale, CA 94089
salessupport@QuietSolution.com